



**Mostostal**  
PUŁAWY



**MOSTOSTAL PUŁAWY  
GROUP**

Let us tell you more about us

MANAGEMENT BOARD OF MOSTOSTAL PUŁAWY S.A.



**Tadeusz Rybak**  
President of the Board of Mostostal Puławy S.A.



**Jerzy Świeca**  
Vice President of the Board of Mostostal Puławy S.A.

**M**ostostal Puławy is a reliable partner in business:

- We employ almost 1300 employees.
- We care about sustainable development.
- A socially responsible and environmentally friendly company.
- KNOWLEDGE – QUALITY – EXPERIENCE – PUNCTUALITY are our attributes.

## STRUCTURE OF MOSTOSTAL PUŁAWY GROUP

# Mostostal

PUŁAWY

[mostostal-pulawy.com.pl](http://mostostal-pulawy.com.pl)

ul. Budowlanych 5, 24-110 Puławy, Poland  
 tel. (+48) 81 477 58 80  
 fax (+48) 81 473 12 44  
 e-mail: [info@mostostal-pulawy.com.pl](mailto:info@mostostal-pulawy.com.pl)

## SUBSIDIARIES

## Mezap

Grupa Mostostal Puławy

Zakład Budowy Aparatury i Remontów Specjalistycznych  
 Mezap sp. z o.o.

ul. Ignacego Mościckiego 14, 24-110 Puławy, Poland  
 tel. (+48) 81 473 15 30, fax (+48) 81 473 15 31  
 email: [info@mezap.pl](mailto:info@mezap.pl)  
[www.mezap.pl](http://www.mezap.pl)

## Energezap

Grupa Mostostal Puławy

Przedsiębiorstwo Remontów Energetycznych  
 Energezap sp. z o.o.

ul. Ignacego Mościckiego 14, 24-110 Puławy  
 tel. (+48) 81 473 13 03, fax (+48) 81 473 13 00  
 email: [energezap@energezap.pl](mailto:energezap@energezap.pl)  
[www.energezap.pl](http://www.energezap.pl)

## OFFICES/BRANCHES

## Technical Office in Germany



Moerser Str. 85  
 D-40667 Meerbusch, Germany  
 tel. (+49) 21 32 75 95 76  
 fax. (+49) 21 32 75 95 78  
 e-mail: [mail@mostostal-pulawy.de](mailto:mail@mostostal-pulawy.de)

## Branch office in the UK



238a King Street  
 W6 0RF London, UK  
 tel. (+44) 20 81 90 04 55  
 e-mail: [info@mostostal-pulawy.co.uk](mailto:info@mostostal-pulawy.co.uk)  
[www.mostostal-pulawy.co.uk](http://www.mostostal-pulawy.co.uk)

Enjoying the trust  
of customers  
in the entire Europe



LONDON

Mostostal  
PUŁAWY

Mostostal  
PUŁAWY

MEERBÜSCH/DÜSSELDORF



**Mostostal**  
PUŁAWY



**ambasador**  
POLSKIEJ GOSPODARKI

**Mostostal**  
PUŁAWY



**M**ostostal Puławy has been dynamically developing on the Polish market, simultaneously running its export business that has been an important segment of the contracts being performed. Our experience in export-related services began as early as in the last century. The group specialises in design engineering, manufacturing and erecting steel structures and special equipment in the industrial construction sector. Our customers also appreciate the Group's specialised overhaul and repair services.

## MOSTOSTAL PUŁAWY GROUP

**M**ostostal Puławy Group is a member of the elite group of companies specialising in manufacturing and erection of steel structures and performance of construction projects. According to our company's policy, each customer is offered the finest quality of our products and services. We employ highly qualified and experienced inspection and production staff. The company has modern equipment at its disposal. Reliable operation that began in the 60s of the 20th century in all business areas of our enterprise allowed us to gain a business partner status that is appreciated and desired by customers in the entire Europe. What we find important is the development of the company and continuation of the tradition based on the values such as quality, timely completion, reliability and cooperation.

**M**ostostal Puławy Group offers a wide range of services in the most important economy areas of the market: power industry and environmental protection, communication infrastructure, civil construction and industrial construction. Numerous awards and distinctions earned by our group in competitions organised for the most significant Polish entrepreneurs clearly confirm the position and reliability of our enterprise brand – Polish Economy Ambassador and Lublin Voivodeship Ambassador. Mostostal Puławy S.A. Group is an inseparable element of the Puławy industrial region. For many years of hard working, we have proven that trust and loyalty are perfect binding elements to establish long-lasting economic entities. Mostostal Puławy S.A. has been operating as a capital group since 2005. The development of the group is based on a cohesive strategy and cooperation.





## TECHNICAL OFFICE IN GERMANY

The Technical Office of Mostostal Puławy in Germany was established in 1997. The seat of the office is located in Meerbusch near Düsseldorf. For our foreign customers, the office offers services associated with comprehensive erection of steel structures and supply of structures manufactured in Puławy, specialised apparatuses and pressure equipment. The group of our regular customers includes international companies that construct conventional power plants, supply technology for thermal waste treatment and manufacture membrane walls and pressure equipment. The office also cooperates with companies in construction of specialised clinics and hospitals in the modular system, installation of modern thermal insulation systems for buildings, overhaul works in car factories of the leading German car manufacturers.



## BRANCH OFFICE IN THE UK

The branch office of Mostostal Puławy S.A. In the UK was established in 2017. The seat is located in London. The decision to establish the office was made after an analysis of the British market that has been a great share of the portfolio of projects ordered to the Company for years. Having a branch office enable better flexibility during performance of contracts, authentication of the company from the customers' point of view and ensuring daily contacts with the British legal system, which is important once the UK commenced its withdrawal from the European Union. The office deals with contracts being performed and acquires construction work orders, with particular reference to the power sector and industrial systems.



Sevenside waste incineration plant in Bristol, UK



Metsä Fibre Oy in Äänekoski, Finland



Erection of evaporation plant at paper mill owned by Södra Cell Mörrum, Sweden



Waste incineration plant in Ferrybridge, UK

## MOSTOSTAL PUŁAWY GROUP

### MEZAP sp. z o.o.

The beginning of Mezap Sp. z o.o. dates back to 1963 when the company started its business as Zakład Mechaniczny that functioned within the structure of Zakłady Azotowe "Puławy". In 1993, a new independent enterprise was established.

The main areas of the company's operations are construction and repairs of pressure apparatuses and equipment used in the chemical, petrochemical, power, food and paper industry. The main manufacturing profile of the company involves fabrication of heat exchangers, reactors, boilers and pressure tanks made of all steel grades (carbon, alloy, duplex) as well as aluminium, nickel, titanium and their alloys.

The equipment is manufactured in accordance with requirements of the Office of Technical Inspection (UDT), TÜV, EN-13445, EN-12952 and PED Directive 2014/68/EU. In addition, the company has a specialised crane and weighing team.



Supply of heat exchangers to Swedish OUTOTEC



Tower DK-102



Restoration of exchanger E-2211 for ANWIL S.A., Poland



## ENERGEZAP sp. z o.o.

Energezap sp. z o.o. provides services in erection and repair associated with mechanical works of the main equipment in the CHP plant at Zakłady Azotowe "Puławy" S.A., particularly steam boilers and turbines as well as auxiliaries and boiler-related systems, the turbine room, coal handling, water preparation and electric power networks.

The company prefabricates and erects elements of steel structures, piping systems and systems made of PVC pipes and plates. The company holds professional licences for the production, assembly, retrofit and repair of pressure equipment and pipelines, granted by the Office of Technical Inspection (UDT). The systems implemented by the company comply with Pressure Equipment Directive 2014/68/EU.

The company has a workshop floor with an area of 2500 m<sup>2</sup> at its disposal; the workshop is equipped with a toolmaker's shop, machining centres, electrical and gas welding equipment as well as machines for thermal treatment of welded joints.

**Energezap**  
Grupa Mostostal Puławy



Disassembly of turbine set for Zakłady Azotowe "Puławy" S.A., Poland



Fitting ready to assembly in steam and system of OP-215 boiler, Poland



Zakłady Azotowe "Puławy" S.A., Poland

**Mostostal**  
PUŁAWY





## We are proud of our history



**T**he establishment of Mostostal Puławy was associated with the construction of the so-called large chemical synthesis in Poland. In 1964, a branch site of the Steel Structures and Industrial Equipment Enterprise in Warsaw was established in Puławy to construct process plants at Zakłady Azotowe.

**1964**

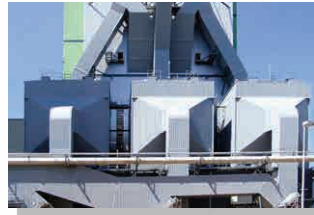

**I**ntensive development of export operations resulted in establishment of the Technical Office in Germany in 1997. It is now located in Meerbusch near Düsseldorf.

**1997**

**1994**

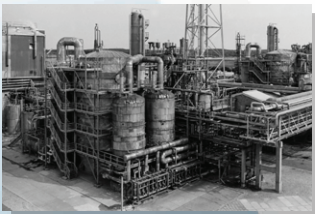

**L**ater, the branch site in Puławy was transformed into a limited liability company. The period of political and government system transition in Poland forced the company to find its place in new economic circumstances. During that period, Mr Tadeusz Rybak was appointed President of the Management Board.



**1998**



**D**ynamic enterprise growth, new challenges and cooperation with business partners were the reasons for which Mostostal Puławy was transformed into a joint-stock company in 1998.



**W**hile expanding its offer and developing its potential, the company purchased two companies from Zakłady Azotowe: Mezap sp. z o.o. and Energezap sp. z o.o.

**2005**



**"50** years forged in steel" Golden Jubilee. The Management Board and the staff were awarded by government and local-government authorities. Tadeusz Rybak, President of the Management Board, was awarded Knight's Cross of the Order of Polonia Restituta by the President of Poland. In December 2014, Mostostal Puławy S.A. was sold by Mostostal Warszawa to new owners. The shareholder group included the current Management Board of Mostostal Puławy S.A. as well as directors and entrepreneurs based in Puławy.

**2014**

**A** branch office of Mostostal Puławy S.A. was established in the UK.

**2017**

**2009**

**A**t the Royal Castle in Warsaw, Tadeusz Rybak, President of the Management Board, collected the title of the Polish Economy Ambassador presented personally by the Minister of Foreign Affairs. The company was awarded the prestigious distinction in the category: exporter.

**2011**

**T**he Company was awarded the distinction of "Lublin Voivodship Ambassador" by the expert and media jury chaired by the Marshal of the Lublin Voivodship.



**2015**



**M**ostostal Puławy S.A. was awarded a diploma for the best exporter in a contest "Orły Eksportu" organized by Ministry of Economy and "Rzeczpospolita" daily.

Let's create the future

**M**ostostal Puławy Group is the largest construction company in the region. Each day, we prove that trust and loyalty are perfect bonding materials to create long-lasting organizational culture. Thus, we look into the future full of hopes and confidently set new goals to be achieved.

**Mostostal**  
PUŁAWY





## MOSTOSTAL PUŁAWY GROUP'S PROPOSAL

### DESIGN OFFICE

The Design Office incorporated into the structure of Mostostal Puławy S.A. offers development of design documentation at every stage of project implementation.

The Design Office offers complete:

- Building designs.
- Mechanical designs.
- Detailed designs.
- Workshop drawings of steel structures.
- Erection method statements.

The services are provided based on the cutting-edge software and expertise of our design engineers.

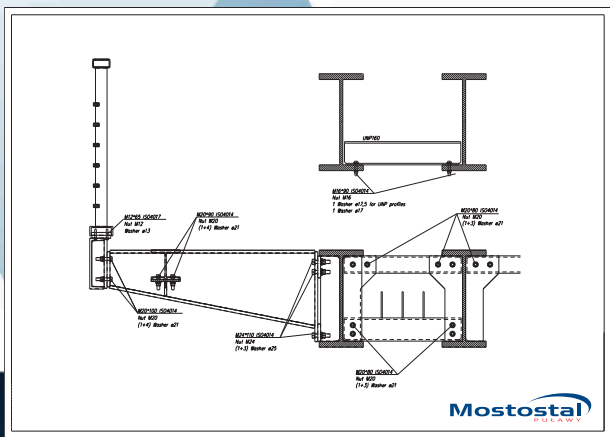
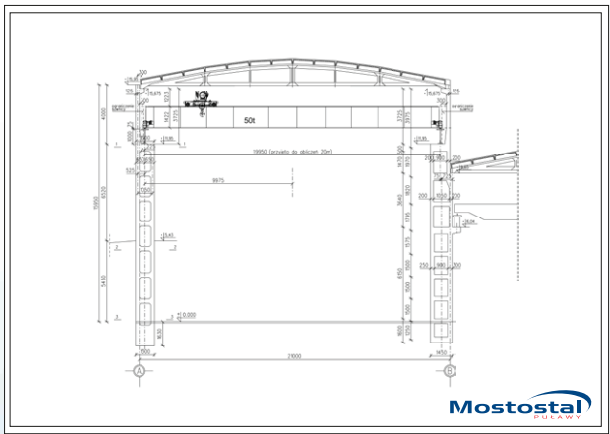

### LIFTING SERVICES

Mostostal Puławy S.A. Group provides specialised lifting services. The company owns the most modern equipment from reputable manufacturers, with a lifting capacity ranging from 10 to 220 tonnes.

- Mobile cranes – lifting capacity from 10 to 220 tonnes.
- Rough terrain cranes – lifting capacity from 75 tonnes.
- Tower cranes – load capacity up to 120 Tm.
- Man lifts – working height up to 40 m.
- Telescopic handlers.





## STEEL STRUCTURES MANUFACTURING PLANT, PREFABRICATION PLANT AND PAINT SHOP

**M**ostostal Puławy S.A. has been manufacturing and exporting steel structures for more than 50 years. The manufacturing plant has a lifting capacity up to 40 tonnes (60 tonnes if mobile cranes are used) and can handle elements with the dimensions 4 m in height x 4.5 m in width x 40 m in length. The plant has a large production and storage area exceeding 11 000 square meters. The monthly production capacity is 700 tonnes.

The Steel Structures Manufacturing Plant of Mostostal Puławy and the Prefabrication Plant manufacture steel structures for the power chemical and petrochemical, metallurgy, mining and infrastructure: road, railway, harbour, industrial as well as construction of hall buildings, sports and public utility facilities.

The offer includes large-scale structures, pressure tanks, industrial pipelines, silos, ducts, filters, fan casing, towers, bridges, overpasses, pedestrian bridges, flyovers, conveyor casing, hoists, railing, components of equipment and other special welded structures. Our structures are made of different steel grades structural, pressure, stainless, high-temperature, heat-resistant steels, also with the use of aluminium, zinc alloys and plastic.

With qualified and experienced staff members as well as continuously developed machinery fleet, we can provide our customers with high quality and modern manufacturing technologies for the offered products and services. The production process technology is always prepared and constantly monitored by experienced staff of Technologists Department and Welding Department.

The company has a modern Anticorrosion Protection Department. With our experienced and licensed staff members, the plant provides structures with corrosion protection applied by different coating systems based on modern methods, technologies and materials. Surface protection is applied by hydrodynamic coating, metal spraying, chemical-resistant protection, heat-resistant protection, layer-to-layer bonding membrane protection, fire resistant protection, surface rubber coating and zinc plating.

Permanent supervision of quality of our products is ensured by the Quality Control and Assurance Department together with a NDT laboratory. Numerous professional licences, approvals and certificates guarantee that all our products have high quality and comply with standards and meet customer expectations.

The internal quality assurance system is based on valid international industrial standards such as PN/EN/DIN/ISO/ANSI.

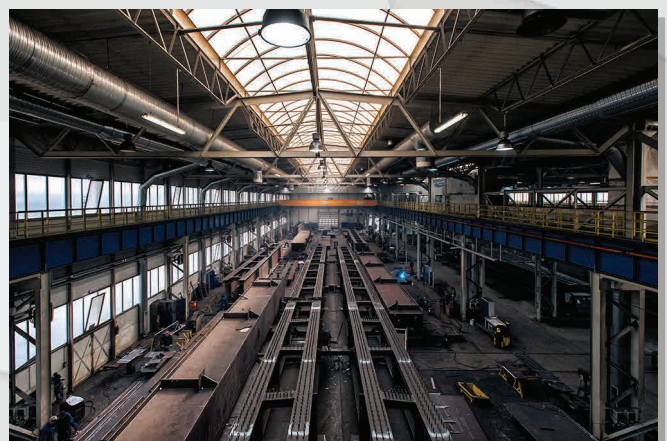

We respond to our customers' needs

## GENERAL CONTRACTOR PROJECTS

### INDUSTRIAL CONSTRUCTION

#### POWER INDUSTRY

**M**ostostal Puławy Group is dynamically developing in this market segment.

Our services apply to:

- CHP plants.
- Conventional power stations.
- Gas power stations.
- Wind power stations.
- Biogas plants.



Erection of BFB boiler in Havo CHP plant, Finland



Waste incineration plant Trident Park in Cardiff, UK



Spherical tanks Orlen in Plock, Poland



LKAB Svappavaara mine, Sweden

### CHEMICAL AND PETROCHEMICAL INDUSTRY

**M**any years of experience in cooperation with global leaders in chemical and petrochemical industry makes us a reliable contractor of the following ventures:

- Specialised storage systems dedicated to products in the chemical and fuel industry: tanks, storage facilities and apparatuses.
- Handling terminals and transport systems dedicated to the products in the chemical processing industry/chemicals and chemical products and fuels.
- Systems for mass production of chemical and low-tonnage products.

### ENVIRONMENT PROTECTION

**R**eferred especially to the last decade, we can proudly mention our numerous projects in the environment protection sector. Our services apply to:

- Flue gas desulphurisation, denitrification and dedusting systems.
- Electrostatic precipitators – ESPs.
- Municipal waste disposal plants (sorting plants, composting plants).
- Waste water treatment plants.
- Sewage sludge combustion systems.
- Boilers in waste and biomass (woodchips, straw etc) incineration plants.





We are the general contractor  
in many projects

**ENCLOSED  
STRUCTURES**

**SPORT AND LEISURE FACILITIES**

- Sports and entertainment arenas.
- Stadiums.
- Leisure facilities.
- Indoor swimming pools.



Cycling stadium in Pruszków, Poland

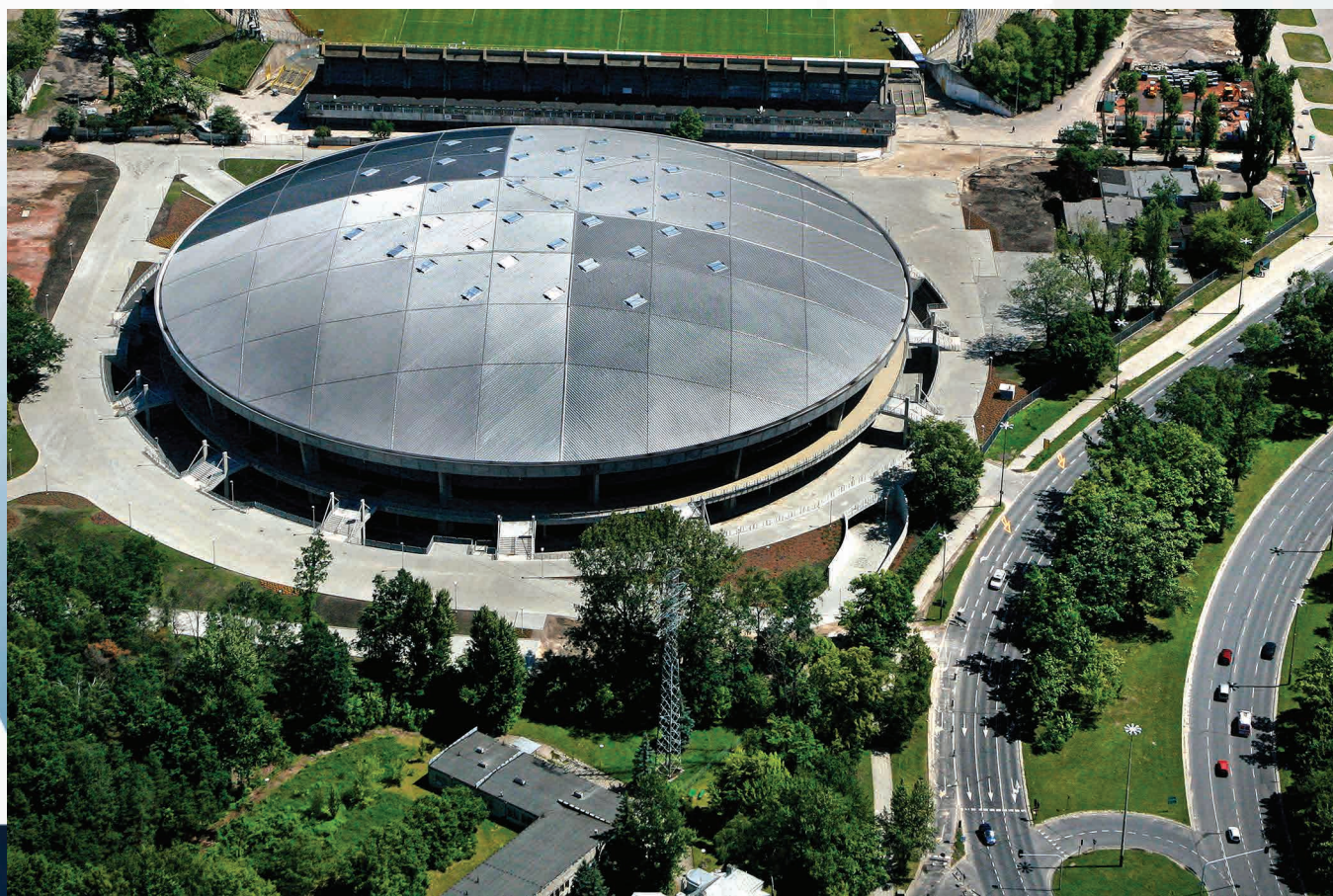

Sports hall in Łódź, Poland

Our work is appreciated by investors and business partners

### URBAN INFRASTRUCTURE FACILITIES

- Retail and service centres.
- Multiplexes.
- Multi-storey car parks.



Renault car showroom in Lublin, Poland

### PRODUCTION HALL BUILDINGS AND STORAGE FACILITIES

We recognise the importance of timely completion and quality in business. Therefore, we always attempt to cooperate with our partners to ensure effective completion of the contracts entrusted to us.



Zakłady Azotowe "Puławy" S.A., Poland



Waste sorting facility in Regionalny Zakład Zagospodarowania Odpadów in Dębowiec, Poland

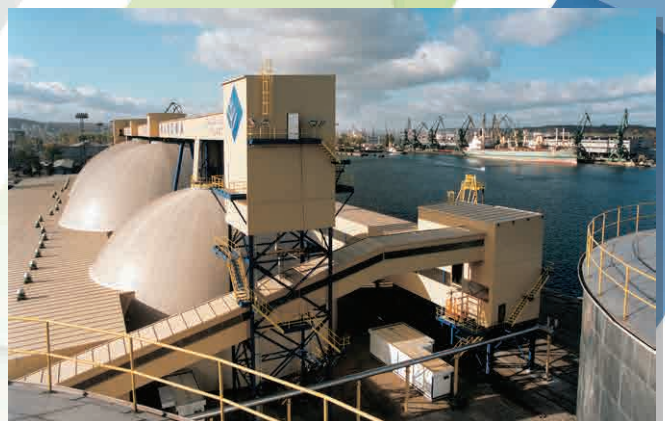

Baltic Bulk Terminal, Zakłady Azotowe "Puławy" S.A., Poland

The projects that serve people are our hallmark

## COMMUNICATION INFRASTRUCTURE

- Bridges.
- Overpasses.
- Flyovers.
- Border crossing points.
- Terminals.
- Specialised military facilities.



The Third Millenium John Paul II Brodge over the Vistula River in Gdańsk, Poland



The John Paul II Bridge over the Vistula River in Puławy, Poland



The Świętokrzyski Bridge, Poland





The bridge in Przemysł, Poland



The pylon of the footbridge over Malta lake in Poznań, Poland



The Siekierkowski Bridge over the Vistula River in Warsaw, Poland

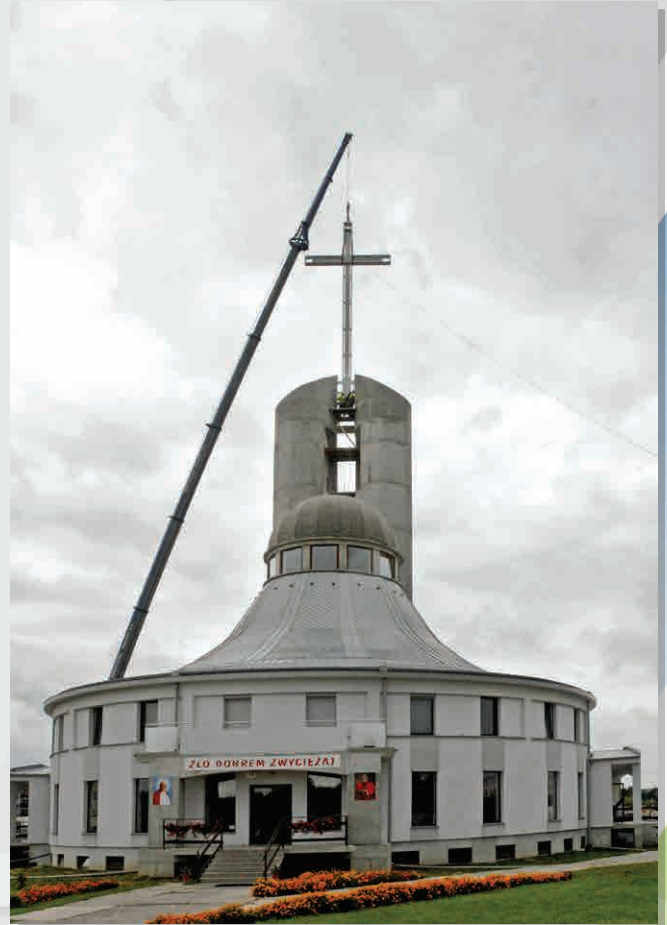

Erection of the cross on the John Paul II Church in Lublin, Poland

## SACRAL PROJECTS

Within sacral projects Mostostal Puławy provides design and manufacturing of construction elements as well as their assembly. In our offer there are:

- Domes.
- Crosses.
- Roofing.

**Mostostal**  
PUŁAWY





ostal

Cooperation within Mostostal Puławy Group provides many possibilities

## CONSTRUCTION AND OVERHAULS OF APPARATUSES AND EQUIPMENT

- Pressure and non-pressure tanks.
- Boiler drums.
- Steam and water boilers.
- Various types of heat exchangers.
- Draining and jacketed coolers.
- Reactors.
- Boiler coiling systems.
- Column apparatuses.
- Filter casings.
- Agitators, evaporators, separators.
- Absorbers.
- Drums.
- Regenerating units.



Towers for SSBR projects



Absorber 153K2



Manufacture of galvanic tanks for General Electric in the Arab Emirates



Tower ASPHALT FLASH 1100-C4



Overhaul hall – Energezap sp. z o.o., Poland

### MODERNISATION AND RETROFIT SERVICES

- Overhaul of centrifugal single-stage and multi-stage pumps.
- Renovation of tanks.
- Overhaul of conveyors.
- Steam boilers.
- Coal mills.
- Steam turbines.
- Heat exchangers.
- Belt conveyors.

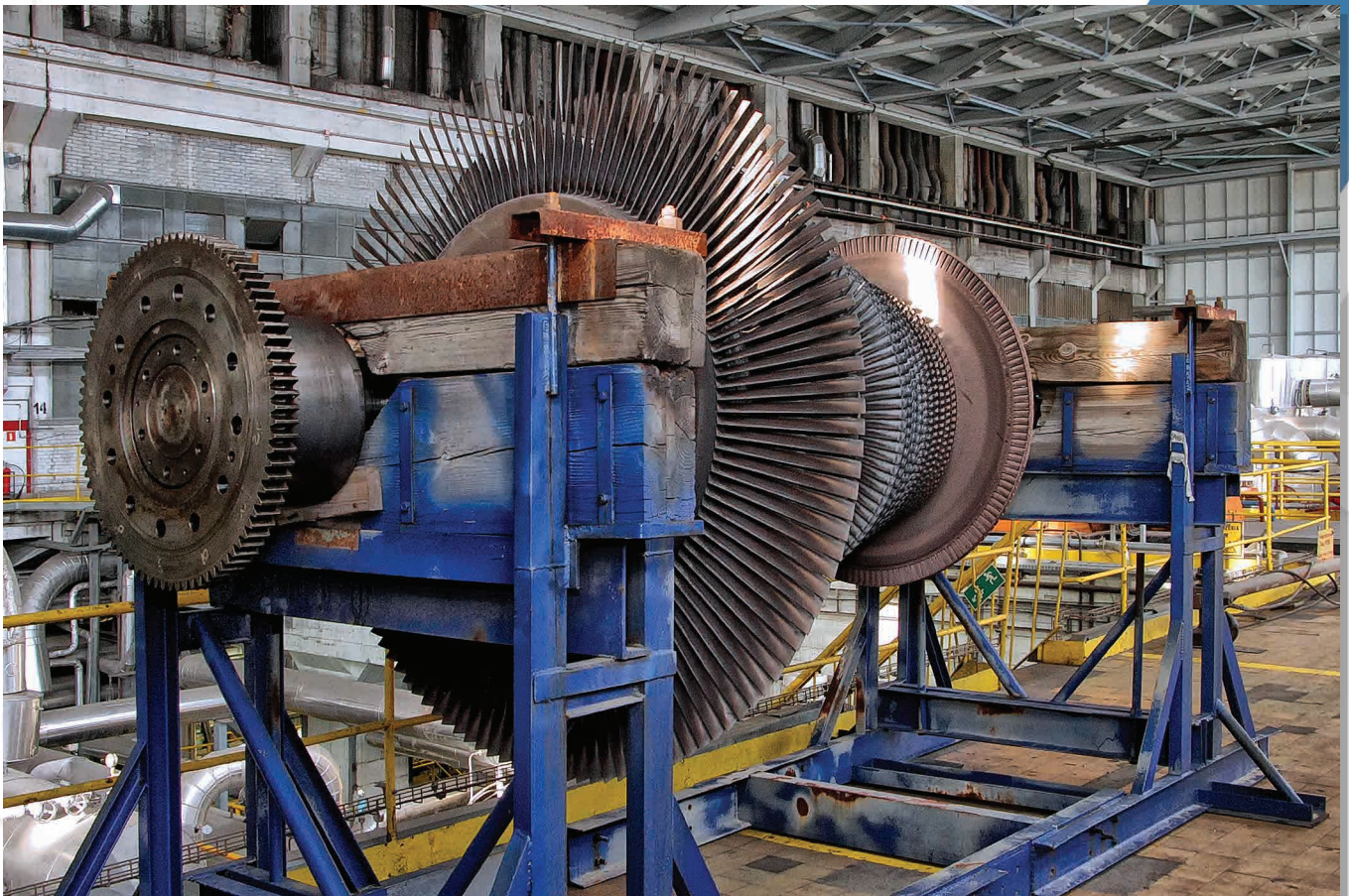

Disassembly of turbine set TG2 for Zakłady Azotowe "Puławy" S.A., Poland

**Mostostal**  
PUŁAWY





We are constantly improving, working and controlling the results

## INTEGRATED MANAGEMENT SYSTEM

### INTEGRATED MANAGEMENT SYSTEM CERTIFICATES

- Certificate of the Quality Management System acc. to PN EN ISO 9001:2015.
- Certificate of the Environmental Management System acc. to PN EN ISO 14001:2005 9001:2015.
- Certificate of the Occupational Health and Safety Management Systems acc. to PN-N-18001:2004 and BS OHSAS 18001:2007.
- Certificate of the Quality Management System that complies with AQAP 2110:2009.

### THE OFFERED EQUIPMENT IS MANUFACTURED BASED ON THE FOLLOWING REGULATIONS

- Office of Technical Inspection (UDT) in Poland.
- Technischer Überwachungs-Verein (TÜV) in Germany.
- European Standards EN- 13445, EN-12952, EN 13 480 and PED Directive 97/23/ECE and Directive 2014/68/EC.
- The American Society of Mechanical Engineers (ASME).

### CERTIFICATES, LICENSES

- Factory Production Control Certificate that confirms the compliance with Standard PN-EN 1090-1+A1:2012 IDT EN 1090-1:2009+A1:2011

- OHS Management System Certificate acc. to SCC\*\*2008/5.1, issued by DNV.
- TÜV SÜD Certificate – verification of the Manufacturing Plant in connection with Module G acc. to Directive 97/23/WE.
- Certificate confirming full compliance with welding quality requirements acc. to EN ISO 3834-2
- System Certificate.
- TÜV SÜD Certificate relating to transferring of material markings pursuant to 97/23/EC and 2014/68/EC, Annex I, Chapter 3.1.5, EN 764-5, Clause 6.2.2, AD 2000 HPO, Clause 4
- TÜV SÜD certificate for a manufacturer acc. to AD 2000-Merkblatt HP 0/HP 100R, TRD 201 and EN ISO 3834-2 confirming the compliance with welding requirements during production of pressure equipment pursuant to the Pressure Equipment Directive 97/23/WE.
- TÜV SÜD Attestation no. TSPL/HT-14/001 TUV SUD confirming that the company complies with the requirements of AD 2000 – Merkblatt HP 7/1, Chapter 2, and EN ISO 17663, applicable to companies that provide thermal treatment.
- Certificate of conformity EU issued by the Office of Technical Inspection (UDT) confirming that Mostostal Puławy S.A. complies with requirements of Module A2 of Directive 2014/68/WE as regards pressure equipment manufacturing.

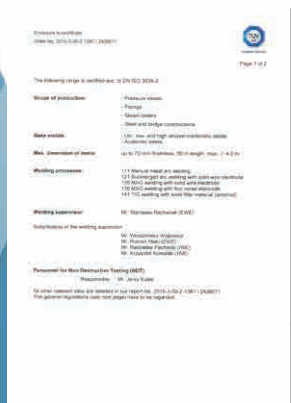



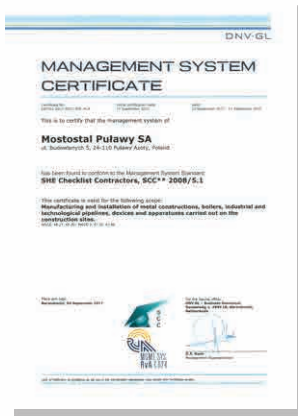

PROFESSIONAL LICENCES

- Licences granted by the Office of Technical Inspection authorising our company to manufacture, erect, upgrade and repair:
  - steam and water boilers;
  - steam piping;
  - transmission pipelines of liquid and gaseous media;
  - process pipelines operated with liquid and gaseous media;
  - non-pressure tanks and pressure tanks for liquid flammable materials;
  - mobile tanks;
  - stationary pressure tanks;
  - non-pressure tanks and pressure tanks for toxic or corrosive materials and pressure equipment components.
- Licences granted by the Office of Technical Inspection authorising us to manufacture, retrofit and renovate technical equipment subject to Transportation Technical Supervision (TDT).

CERTIFICATES

- Qualification Certificates granted by the Qualification Committee of the Manufacturers of Bridge Steel Structures:
  - Qualification certificate no. 22/15 concerning the production of bridge steel structures;
  - Qualification certificate no. 22/M/15 concerning the renovation and erection of bridge steel structures.
- Acknowledgement Certificate for Laboratory to the Non-destructive Testing Division at Mostostal Puławy S.A., granted by the Office of Technical Inspection
- Steel Structure Manufacturer Certificate.

## We are a company with corporate social responsibility

The business of Mostostal Puławy Group applies corporate social responsibility (CSR) principles. We attempt to achieve not only financial results and, at the same time, manage our potential, but also we care about the development of the region, respond to social needs and take care about the environment. For our employees, we arrange many team building events, support their development by means of specialised trainings and provide learning of foreign languages. The employee fund is used to provide loans, refund holidays and trips.

In 2005, our company co-financed the promotion of the region of Lublin in the European Parliament in Brussels. We also support institutions and development programmes that are important for the local community. Our company cooperates particularly with educational institutions, secondary schools, universities, local self-governments, hospitals, hospices, the Polish Social Welfare Committee and the "Dom Chemika" Cultural Centre in Puławy.



### Biały Listek CSR POLITYKI

w VI zestawieniu firm  
odpowiedzialnych  
społecznie  
za 2016 rok



## Mostostal Puławy SA

Gratulujemy!

Inna Pichla  
Partner/Leader of Sustainability Consulting  
Central Europe

*Inna Pichla*

**Deloitte**

Język Baczyński  
Prezenter Naczelny  
POLITYKA

*Język Baczyński*

**POLITYKA**

## CULTURE AND SPORT PATRONAGE

Our company is a recognised patron of culture, art, science and sports. The company provides substantial, technical and financial support during many cultural events taking place within Lublin Voivodeship. We participate in scientific and social events that are important for the region.

Since 1997, we have been supporting the local KS "Pogoń" Mostostal Puławy cycling section. The club is known and recognised both in the region and in Poland; the contestants of the club achieve many successes in regional and all-Poland competitions. The KS "Pogoń" Mostostal Puławy contestants are the winners of the European Championships. Important sport initiatives are always recognised and supported by our company.

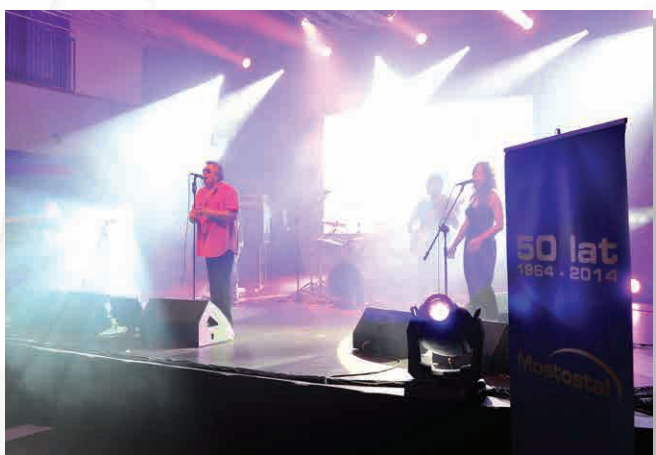

**Mostostal**  
PUŁAWY



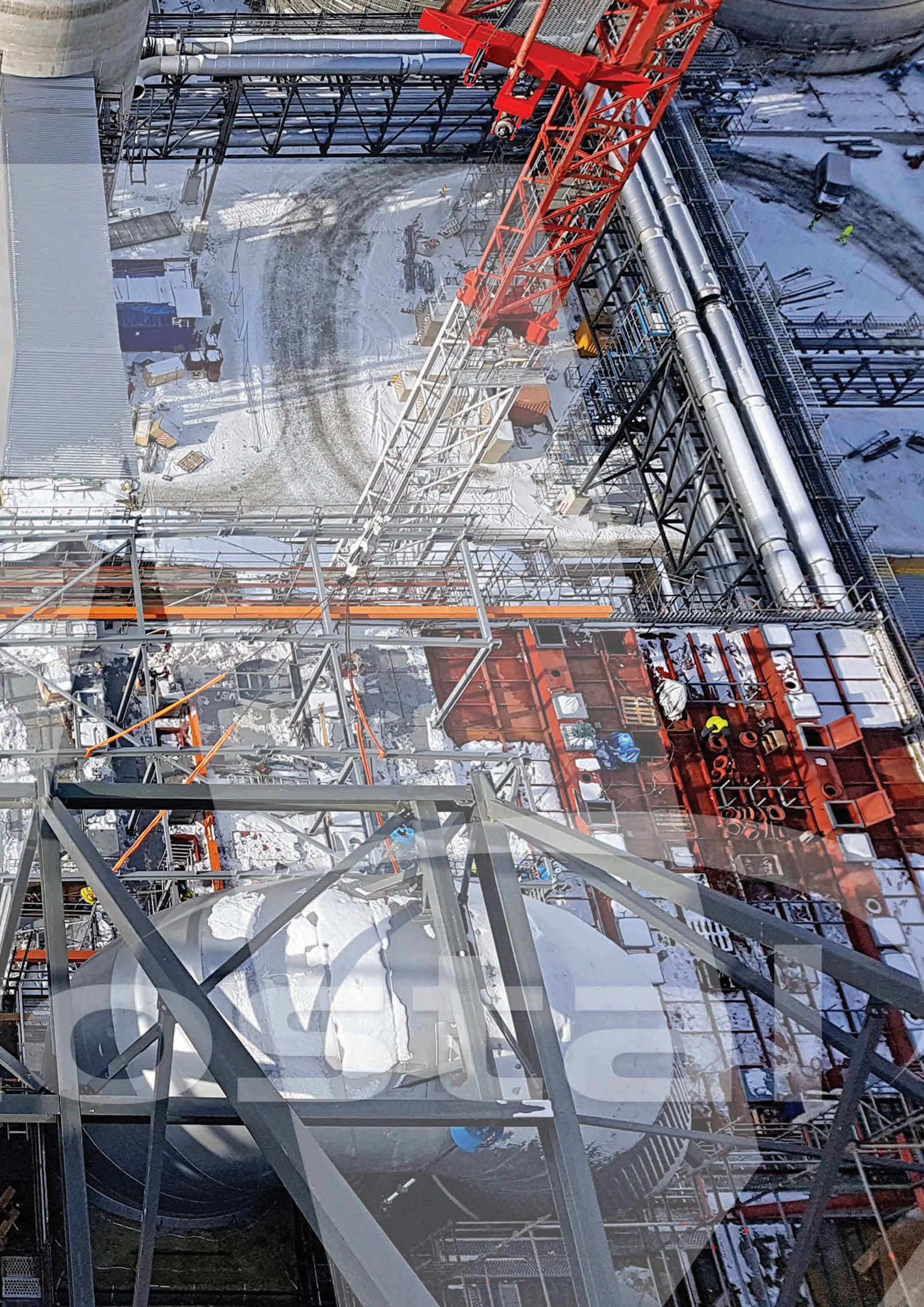

## AWARDS, TITLES, DISTINCTIONS

The companies of Mostostal Puławy Group receive many awards. We are a member of the Polish Chamber of Steel Structures, the Polish Chamber of Chemical Industry, the Polish Chamber of Power Industry and Environment Protection, Lublin Business Club and the Regional Chamber of Commerce. The company attends thematic meetings, training sessions and international industrial fora.

In the past years, we received many awards and distinctions:

- Forbes' Diamonds in 2017
- Construction Firm of the Year (Budowlana Firma Roku) in 2016
- Sports Pearl of the Lublin Region Distinction (Sportowe Perły Lubelszczyzny) in 2016
- Regional Eagles of Export in Lubelskie Voivodeship (Orzeł Eksportu Województwa Lubelskiego) in 2015
- Grawerton of the Province Government of the Lublin Voivodship on the 50<sup>th</sup> anniversary of Mostostal Puławy S.A. in 2014
- Medal of the Mayor of Lublin on the 50th anniversary of Mostostal Puławy S.A. in 2014
- "Man and company – environment first" Statuette at Ekoforum in 2014
- Sybilla and Puławski Entrepreneur of the Year Statuette in 2014
- The Big Pearl of the Polish Economy (Perła Duża Polskiej Gospodarki) in 2013
- Gold Emblem in the category of Qi Services – the Highest Quality – Quality International 2013
- Well-seen Company (Firma Dobrze Widziana) in 2011
- Lublin Voivodship Ambassador (Ambasador Województwa Lubelskiego) in 2011
- Forbes' Diamonds in 2011
- Business Gazelle Award (Gazele Biznesu) in 2010
- Forbes' Diamonds in 2010
- European Medal in 2010
- Polish Economy Ambassador (Ambasador Polskiej Gospodarki) in 2010







Mostostal Puławy S.A.  
ul. Budowlanych 5  
24-110 Puławy  
tel. (+48) 81 477 58 80  
fax (+48) 81 473 12 44  
e-mail: [info@mostostal-pulawy.com.pl](mailto:info@mostostal-pulawy.com.pl)  
[www.mostostal-pulawy.com.pl](http://www.mostostal-pulawy.com.pl)

Zakład Budowy Aparatury i Remontów  
Specjalistycznych Mezap sp. z o.o.  
ul. Ignacego Mościckiego 10, 24-110 Puławy  
tel. (+48) 81 473 15 30  
fax (+48) 81 473 15 31  
e-mail: [info@mezap.pl](mailto:info@mezap.pl)  
[www.mezap.pl](http://www.mezap.pl)

Przedsiębiorstwo Remontów Energetycznych  
Energezap sp. z o.o.  
ul. Ignacego Mościckiego 14, 24-110 Puławy  
tel. (+48) 81 473 13 03  
fax (+48) 81 473 13 00  
e-mail: [energezap@energezap.pl](mailto:energezap@energezap.pl)  
[www.energezap.pl](http://www.energezap.pl)

